

1993 Chevrolet K1500 Suburban Service & Repair Manual Software

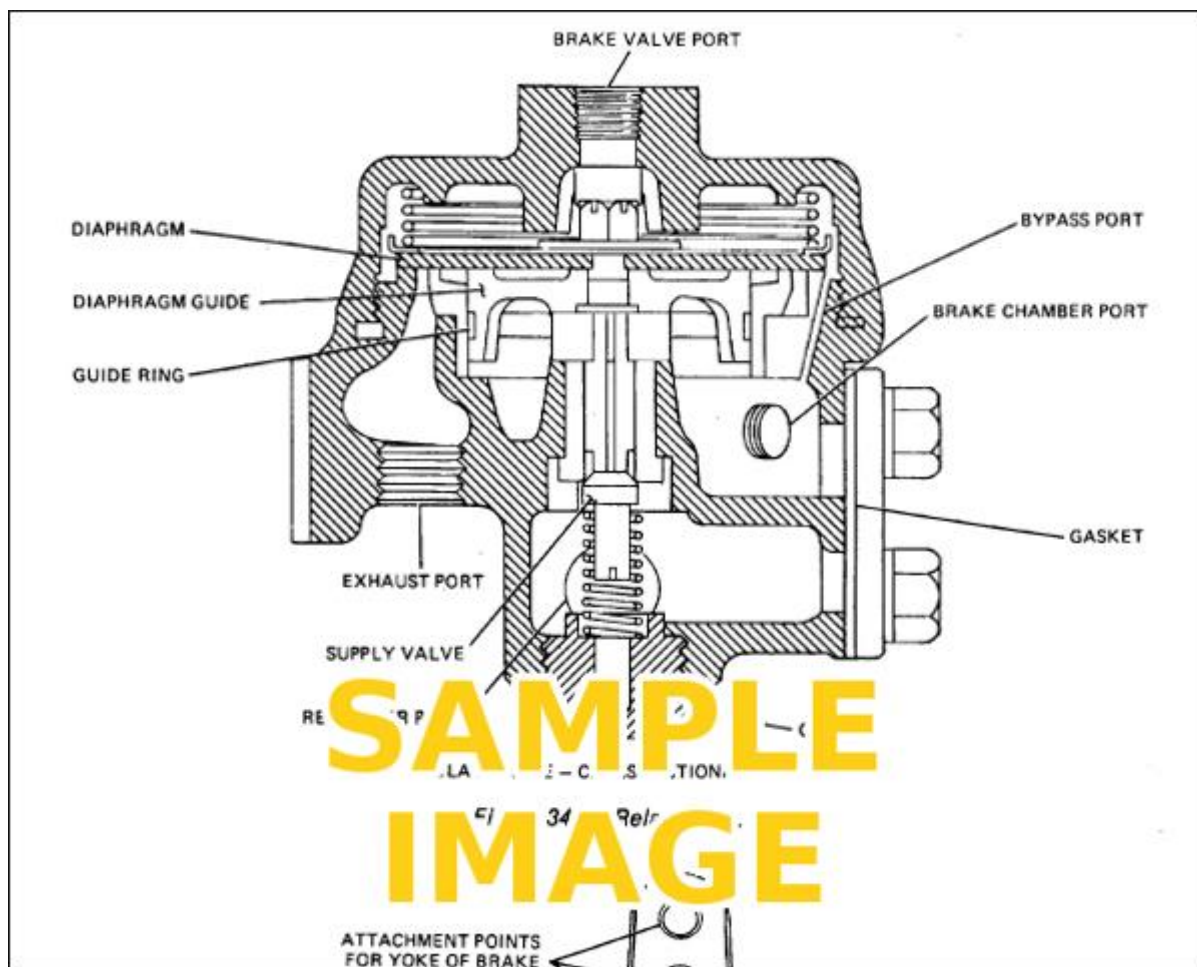

[DOWNLOAD HERE](#)

LICENSED OEM SERVICE AND REPAIR MANUAL SOFTWARE FOR THE 1993 CHEVROLET K1500 SUBURBAN! If you need a repair manual for your Chevrolet, youve come to the right place. Now you can get your repair manual online in convenient digital format. Old paper repair manuals just dont compare! This online repair manual software covers the Chevrolet K1500 Suburban and is perfect for any do-it-yourselfer. In the dark old days of auto repair, you had to buy a traditional service manual in book format which would retail at a higher cost. Getting the same information in digital format is so much less expensive and more convenient! Maybe you need the manual to fix the brakes on your K1500 Suburban, or possibly replace some worn out suspension components. Or you might need to get your engine running, or just do the required standard maintenance. Whatever the case may be, this repair manual software for the Chevrolet K1500 Suburban is just what you need. You will have all the service

information you could ever need for your vehicle. It will help you fix the brakes, engine, suspension, steering, drivetrain, electrical problems, heat, air conditioning, etc. Anything can be fixed! You can save a lot of money by working on your own vehicle. You probably already know this, but mechanics charge a lot. Do it yourself and use this 1993 Chevrolet K1500 Suburban repair manual software to guide the way. It gives you the manual for your K1500 Suburban and its very easy to use. It is compatible with any Windows computer including desktop PCs, laptops, smartphones and tablets. License includes 1-year access to OEM service and repair procedures and unlimited access to supplemental data.

[DOWNLOAD HERE](#)

Similar manuals:

[1986 Chevrolet Gm Kadett Workshop Repair Manual DOWNLOAD](#)

[1995-2001 Chevrolet Cavalier & Pontiac Sunfire Repair Manual](#)

[CHEVROLET SPARK M300 2009-2011 SERVICE REPAIR MANUAL](#)

[CHEVROLET IMPALA SS 1994-1996 SERVICE REPAIR MANUAL](#)

[Chevrolet Chevy 1949 Service Repair Manual Download](#)

[Chevrolet Aveo 2007 Service Repair Manual Download](#)

[Chevrolet Aveo 2007-2010 Service Repair Manual Download](#)

[Chevrolet Aveo 2008 Service Repair Manual Download](#)

[Chevrolet Aveo 2009 Service Repair Manual Download](#)

[Chevrolet Aveo 2010 Service Repair Manual Download](#)

[Chevrolet Chevy 1949-1954 Service Repair Manual Download](#)

[Chevrolet Chevy 1950 Service Repair Manual Download](#)

[Chevrolet Chevy 1952 Service Repair Manual Download](#)

[Chevrolet Chevy 1951 Service Repair Manual Download](#)

[Chevrolet Chevy 1953 Service Repair Manual Download](#)

[Chevrolet Chevy 1954 Service Repair Manual Download](#)

[Chevrolet Aveo 2002 Service Repair Manual Download](#)

[Chevrolet Aveo 2002-2006 Service Repair Manual Download](#)

[Chevrolet Aveo 2003 Service Repair Manual Download](#)

[Chevrolet Aveo 2004 Service Repair Manual Download](#)

[Chevrolet Aveo 2005 Service Repair Manual Download](#)

[Chevrolet Aveo 2006 Service Repair Manual Download](#)

[Chevrolet Aveo Service Repair Manual 2004-2010](#)

[Chevrolet Aveo Service Repair Manual \(Russian\)](#)

[Chevrolet Chevy Shop Service Manual 1949-1954](#)

[Chevrolet Chevy Master Parts Catalog Manual 1929-1954](#)

[Chevrolet Chevy Parts And Illustration Catalog 1958 - 1967](#)

[Chevrolet Corvette Service Repair Manual 1963 - 1983](#)

[Chevrolet Daewoo Service And Repair Manual](#)

[Chevrolet Truck Shop Supplement Manual 1966](#)

[Chevrolet Chevy S-10 Factory Service Repair Manual 1994-2004](#)

[CHEVROLET CORSA PLUS SAIL SGM7165 SGM7166 DIGITAL WORKSHOP REPAIR MANUAL 2005](#)

[CHEVROLET SSR SERVICE REPAIR MANUAL 2003 2004 2005 2006 DOWNLOAD!!!](#)

[Chevrolet Equinox Workshop Service Repair Manual 2005-2008 \(6,600+pages, 940MB, Searchable, Printable PDF\)](#)

[Chevrolet Avalanche 2007 2012 Service Repair Manual Download](#)

[Chevrolet Suburban 2007 2012 Service Repair Manual Download](#)

[Chevrolet Tahoe 2007-2012 Service Repair Manual Download](#)

[Chevrolet Silverado 2007-2012 Service Repair Manual Download](#)

[CHEVROLET CAVALIER SERVICE REPAIR PDF MANUAL DOWNLOAD 1995-2001](#)

[CHEVROLET K1500 SERVICE REPAIR PDF MANUAL DOWNLOAD 1998-1999](#)

[CHEVROLET TRAILBLAZER SERVICE REPAIR PDF MANUAL DOWNLOAD 2002-2006](#)

[CHEVROLET K1500 SERVICE REPAIR PDF MANUAL DOWNLOAD 1996-1997](#)

[CHEVROLET BLAZER V6 SERVICE REPAIR PDF MANUAL DOWNLOAD 1997](#)

[CHEVROLET EQUINOX SERVICE REPAIR PDF MANUAL DOWNLOAD 2005-2009](#)

[CHEVROLET UPLANDER SERVICE REPAIR PDF MANUAL DOWNLOAD 2005-2008](#)

[CHEVROLET BLAZER SERVICE REPAIR PDF MANUAL DOWNLOAD 1996 ONWARD](#)

[CHEVROLET CHEVY CAMARO SERVICE REPAIR PDF MANUAL DOWNLOAD 1982-1992](#)

[CHEVROLET CHEVY TRACKER SERVICE REPAIR PDF MANUAL DOWNLOAD 1999-2004](#)

[CHEVROLET MATIZ SPARK KALOS EVEO SERVICE REPAIR PDF MANUAL DOWNLOAD 2005-2008](#)

[CHEVROLET CHEVY CORVETTE C6 SERVICE REPAIR PDF MANUAL DOWNLOAD 2005-2012](#)