

# 1994 Yamaha 130txrs Outboard Service Repair Maintenance Manual. Factory

/ 140 | - + | 125% | [Icons] | [Icons]

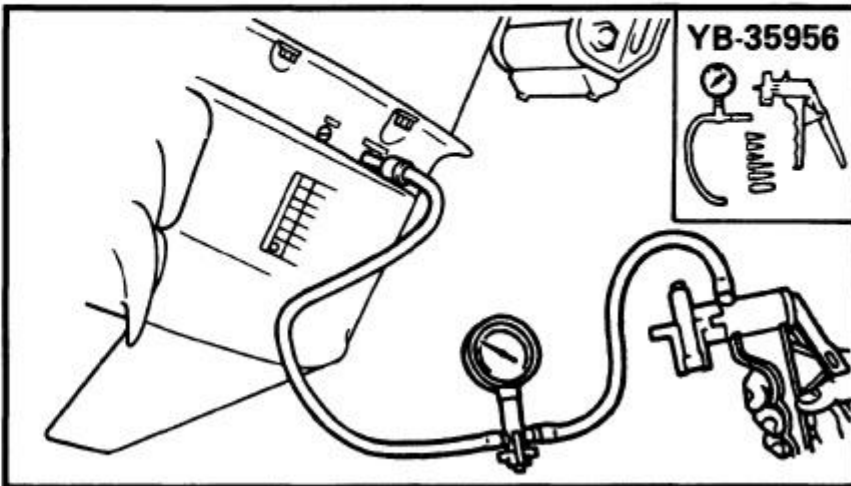
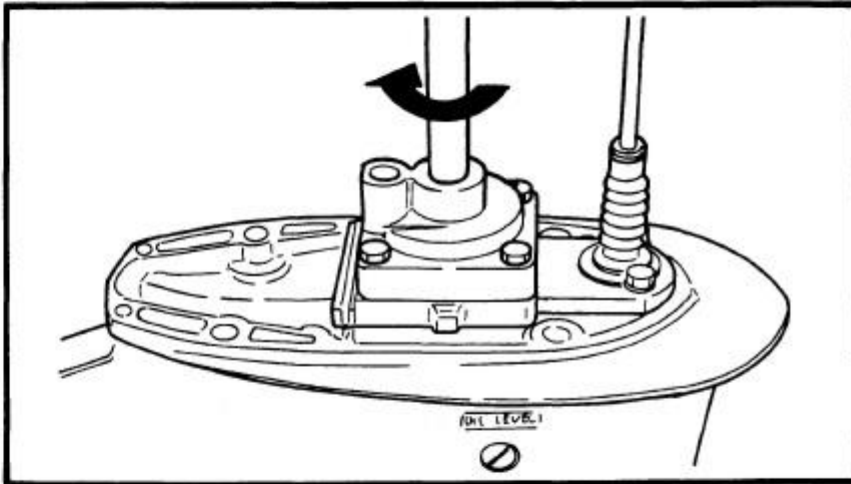
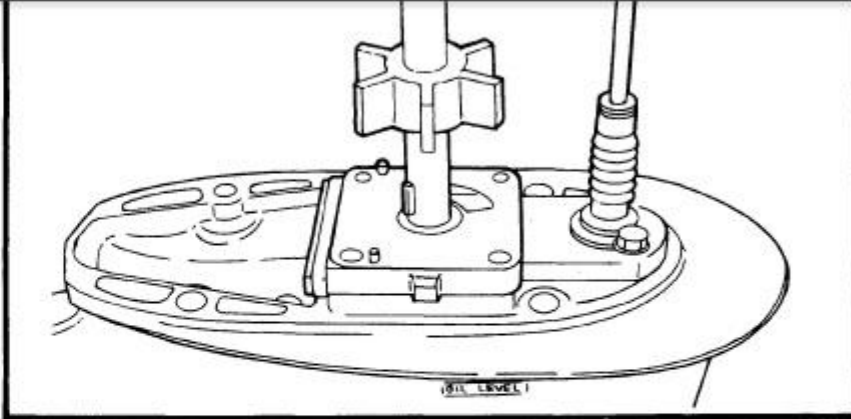

On the oil-seal housing  
4) Install a new key in the  
shaft, and insert a ne

5) Grease the impeller, a  
pump housing, turning  
then tighten the bolts

165000-0

## LOWER UNIT LEAKAGE

- 1) Tighten the gear oil-d  
nect the tester to the
- 2) Pump the tester, and  
100 kpa (1.0 kgf/cm<sup>2</sup>
- 3) Check that the pressu  
(1.0 kgf/cm<sup>2</sup> 14.2 psi)

**NOTE:** \_\_\_\_\_  
If the pressure falls, the lea

[DOWNLOAD HERE](#)

1994 Yamaha 130TXRS Outboards. The procedures in this manual are organized in a step-by-step format. The information has been compiled to provide the mechanic with an easy to read, handy reference that contains comprehensive explanation of all disassembly, repair, assembly and inspection operations. Each chapter provides exploded diagrams before each disassembly section for ease in identifying the correct disassembly and assembly procedures. The manual is completely bookmarked and searchable. It covers everything about the motor.

[DOWNLOAD HERE](#)

### **Similar manuals:**

[Yamaha FZ6-SS\(SSC\) Service Manual, 2004 Model](#)

[Yamaha Blue Tilted Sports Bike](#)

[Sea King 35 45 55 HP Outboard Service Repair Manual 69-80](#)

[Sea King 3.5 4 6 9.2 HP Outboard Service Repair Manual 78-84](#)

[Sea King 9.6 -15 HP Outboard Service Repair Manual 70-84](#)

[Mercury Outboard 2-40 Service Repair Manual 1965-89](#)

[Mercury Outboard 40-115 Service Repair Manual 1965-89](#)

[Force Outboard Motor 4-150 Service Repair Manual 84-99](#)

[Evinrude Outboard Professional Service Manual 1949-1954](#)

[Yamaha Jog CS50 Z Service Manual](#)

[Yamaha Generator Inverter EF3000iseb&c SpplmService Manual](#)

[2012 Yamaha FX NYTRO / XTX / RTX / RTX SE / MTX SE 162 / MTX SE 153 / MTX Snowmobile Service Manual](#)

[2012 Yamaha PHAZER / GT / MTX / RTX / VENTURE LITE Snowmobile Service Manual](#)

[2012 Yamaha VECTOR / LTX / RS VENTURE GT Snowmobile Service Manual](#)

[2012 Yamaha VK PROFESSIONAL Snowmobile Service Manual](#)

[2012 Yamaha APEX MOUNTAIN SE Snowmobile Service Manual](#)

[2012 Yamaha BRAVO LT Snowmobile Service Manual](#)

[2012 Yamaha FX NYTRO / XTX / RTX / RTX SE / MTX SE 162 / MTX SE 153 / MTX Snowmobile Service Manual](#)

[2012 Yamaha PHAZER / GT / MTX / RTX / VENTURE LITE Snowmobile Service Manual](#)

[2012 Yamaha PHAZER GT Snowmobile Service Manual](#)

[2012 Yamaha RS VECTOR GT / LTX GT / RS VENTURE GT Snowmobile Service Manual](#)

[2012 Yamaha VK PROFESSIONAL Snowmobile Service Manual](#)

[2010 Yamaha APEX GT / MOUNTAIN / SE / ER / RTX / RTX ER / GT 40TH ANNIVERSARY / MTX / ATTA / GT Snowmobile Service Manual](#)

[2010 Yamaha APEX MOUNTAIN SE Snowmobile Service Manual](#)

[2010 Yamaha BRAVO LT Snowmobile Service Manual](#)

[2010 Yamaha FX NYTRO / XTX / RTX / RTX SE / MTX SE 162 / MTX SE 153 / MTX Snowmobile Service Manual](#)

[2010 Yamaha PHAZER GT Snowmobile Service Manual](#)

[2010 Yamaha RS VECTOR GT / LTX GT / RS VENTURE GT Snowmobile Service Manual](#)

[2010 Yamaha VK PROFESSIONAL Snowmobile Service Manual](#)

[DOWNLOAD Yamaha Pro Hauler 700 1000 YXP700 YXP1000 04-06 Service Repair Manual](#)

[1998 Yamaha FZS600 Fazer Service Repair Manual DOWNLOAD](#)

[1998 Yamaha RoyalStar Venture Service Repair Manual DOWNLOAD](#)

[2003 Yamaha WR450F Service Repair Manual DOWNLOAD](#)

[1999 Yamaha XJR1300 Workshop Repair Manual DOWNLOAD](#)

[1999 Yamaha XTZ750 Super Tenere Repair Manual DOWNLOAD](#)

[1996-2001 Yamaha XVZ13A RoyalStar Repair Manual DOWNLOAD](#)

[2003 Yamaha YZ450F Service Repair Manual DOWNLOAD](#)

[2003-2004 Yamaha YZF R6 Service Repair Manual DOWNLOAD](#)

[2006 Yamaha YZF R6 Service Repair Manual DOWNLOAD](#)

[2007 Yamaha YZF R6 Service Repair Manual DOWNLOAD](#)

[2008 Yamaha R6 XC Workshop Service Repair Manual DOWNLOAD](#)

[1984-1993 Yamaha FJ 1000&1200 Service Repair Manual DOWNLOAD](#)

[2001 Yamaha Fazer 1000 Service Repair Manual DOWNLOAD](#)

[1988 Yamaha DT 125R Service Repair Manual DOWNLOAD](#)

[2001 Yamaha FJR1300 Workshop Service Repair Manual DOWNLOAD](#)

[2006 Yamaha FRJ 1300 Workshop Service Repair Manual DOWNLOAD](#)

[88-02 Yamaha DT 125R&TZR125 Service Repair Manual DOWNLOAD](#)

[2004 Yamaha FZ6 SS SSC Workshop Service Repair Manual DOWNLOAD](#)

[Yamaha FZR 600 Workshop Service Repair Manual DOWNLOAD](#)

[Yamaha GTS1000 Workshop Service Repair Manual DOWNLOAD](#)